

Bend

INBU 30°

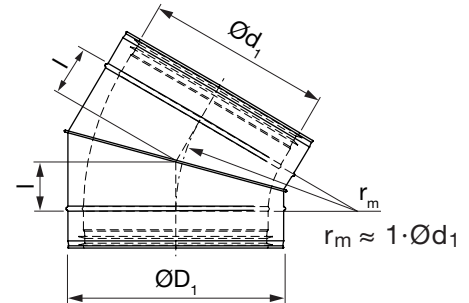

Dimensions



Description

The bend is double-jacketed and insulated with mineral wool, and is supplied with Lindab Safe rubber seal on the inner dimension.

With stop bead at both inner and outer part to ensure correct installation.

Ød ₁ nom	ØD ₁ mm	l mm	m* kg
80	112	27	0,35
100	132	27	0,41
125	157	33	0,55
160	192	43	0,77
180	200	48	0,89
200	232	54	1,11
224	260	60	1,37
250	280	67	1,86
280	315	75	2,59
300	355	95	2,85
315	355	90	3,27

* = weight can vary ±10%.

Order code

