

Bend

INBU 45°

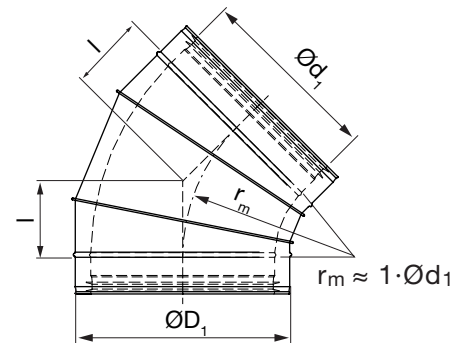

Dimensions



Description

The bend is double-jacketed and insulated with mineral wool, and is supplied with Lindab Safe rubber seal on the inner dimension.

With stop bead at both inner and outer part to ensure correct installation.

Ød ₁ nom	ØD ₁ mm	l mm	m* kg
80	112	41	0,43
100	132	41	0,50
125	157	52	0,68
160	192	66	1,04
180	200	76	1,22
200	232	83	1,46
224	260	93	1,79
250	280	104	2,26
280	315	116	3,24
300	355	124	3,61
315	355	140	4,14

* = weight can vary ±10%.

Order code

